

Features

- Fanless and High Performance Panel PC
- Intel 4th Core-i3/i5/i7 Processor
- On Board DDR3 4GB 1333/1600MHz
- M12 Connector
- SUS304 Grade Stainless Steel Enclosure (SUS 316 Optional)
- Full Flat Bezel Design and Totally IP65/IP69K
- Projective Capacitive Touch / Resistive Touch Window
- 9~36V DC wide-ranging power input



Specifications

System	
Processor	Intel Core i3-4010U Processor (3M Cache, 1.7 GHz) / TDP:15W Intel Core i5-4310U Processor (3M Cache, 2.0 GHz) / TDP:15W
System Chipset	SoC
System Memory	On Board DDR3L 4GB 1333/1600MHz
Storage	1 x 2.5" SATA HDD or SSD (Easily accessible design) 1 x Internal SD Card slot on board
Graphic	Integrated Intel HD graphics 4400

External I/O	
USB	1 x M12 8pin for 1xUSB 3.0 1 x M12 8pin for 2xUSB 2.0
Serial/Parallel	1 x M12 8pin for COM1 /RS-232/422/485 (Default RS-232) 1 x M12 8pin for COM2 /RS-232
Audio	None
Graph	None
LAN	1 x M12 8pin for LAN
Digital I/O	None
Power	1 x M12 3pin DC Power

Expansion	
Expansion slot	1 x Mini PCIe full size For Option WLAN/BT Module and Antenna at rear side
OS Support	Windows 7 Professional for Embedded Systems Windows 7 Ultimate for Embedded Systems Windows Embedded 8 Standard Windows Embedded 8 Pro Windows Embedded 8.1 Pro Windows Embedded 8.1 Industry Pro

LCD	
Display Type	17" TFT-LCD
Max. Resolution	1280 x 1024
Max. Color	16.7M
Luminance (cd/m ²)	350
View Angle	H: 170/V: 170
Contrast	1000:1
Backlight Lifetime	50,000 Hrs

Touch Screen - Projected Capacitive Touch	
Interface	USB
Light transmission (%)	90%

Dimensions

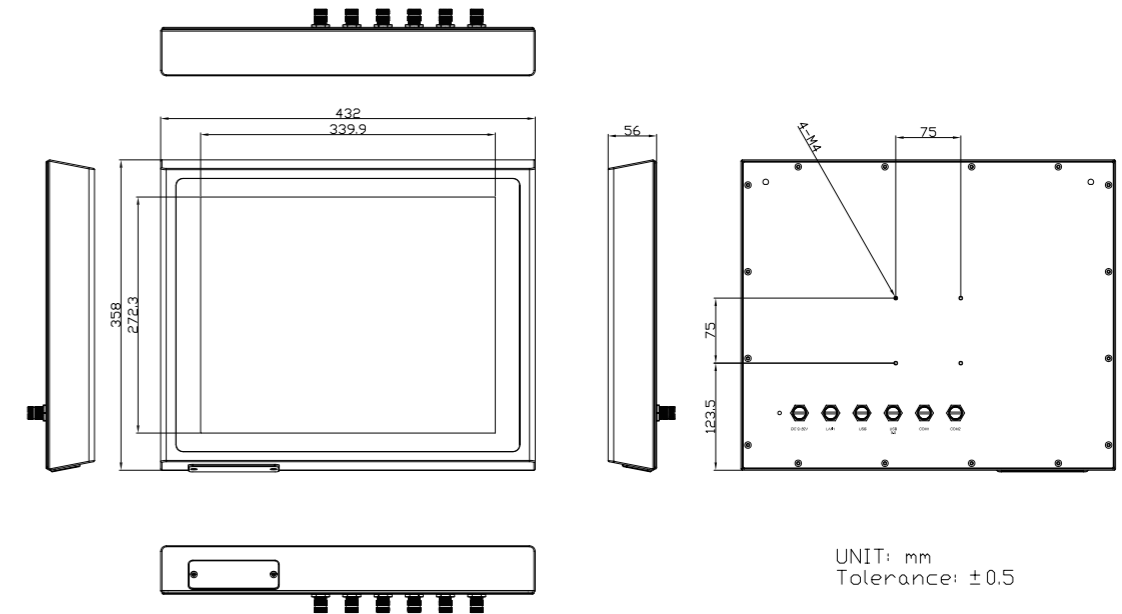

Touch Screen - Resistive Touch Window

Interface	USB
Light transmission (%)	80%

Power

Power input	9~36V DC
Power Consumption	MAX: 36.1W

Mechanical

Construction	Satinless steel
IP Rating	Total IP65/IP69K
Mounting	VESA Mount 75 x 75
Dimension	432 mm x 358 mm x 56 mm
Net Weight	8 Kg

Environmental

Operating temperature(°C)	0°C~50°C
Storage temperature(°C)	-20°C~60°C (with Industrial SSD or CF)
Storage humidity	-30°C~70°C
Certification	10 to 90% @ 40°C, non-condensing CE/FCC class A

Ordering Information

APC-3795P-01	17" SXGA IP65/IP69K full flat bezel design stainless steel panel PC, Intel Core i3-4010U 1.7GHz processor, 4G DDR3L, 2.5" SATA2 320G Industrial HDD, with projective capacitive touch, DC power input with Adaptor, stainless steel enclosure
APC-3795R-01	17" SXGA IP65/IP69K full flat bezel design stainless steel panel PC, Intel Core i3-4010U 1.7GHz processor, 4G DDR3L, 2.5" SATA2 320G Industrial HDD, with Resistive Touch Window, DC power input with Adaptor, stainless steel enclosure
APC-3795P-02	17" SXGA IP65/IP69K full flat bezel design stainless steel panel PC, Intel Core i5-4310U 2.0GHz processor, 4G DDR3L, 2.5" SATA2 320G Industrial HDD, with projective capacitive touch, DC power input with Adaptor, stainless steel enclosure
APC-3795R-02	17" SXGA IP65/IP69K full flat bezel design stainless steel panel PC, Intel Core i5-4310U 2.0GHz processor, 4G DDR3L, 2.5" SATA2 320G Industrial HDD, with Resistive Touch Window, DC power input with Adaptor, stainless steel enclosure